

1 2 3 4 5 6 7 8 9 10

A

B

C

D

E

F

NOTE:

- 1.PUSH FORCE:0.5Kg~2.0Kg
WHEN APPLIED BATTERY MATING SPEED
25±3 mm/min
- 2.STROKE DIMENSIONS: 1.30 mm

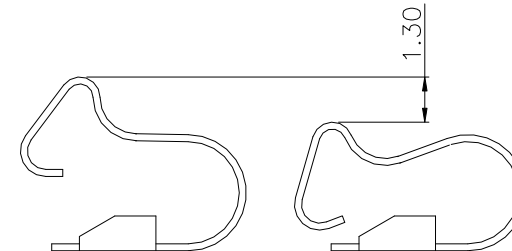

NOTE(1):

RG060191-MA004S200ZL

1.SELECTIVE PLATING

- 'S1,-05u" Min. gold in contact area/
100u" Min. Tin in solder area.
- 'S2,-Gold flash in contact area/
100u" Min. Tin in solder area.
- 'S3,-10u" Min. gold in contact area/
100u" Min. Tin in solder area.
- 'S4,-15u" Min. gold in contact area/
100u" Min. Tin in solder area.
- 'S5,-30u" Min. gold in contact area/
100u" Min. Tin in solder area.
- 'S6,-50u" Min. gold in contact area/
100u" Min. Tin in solder area.

2.PACKAGE:

- L-REEL PACKAGE WITHOUT CAP
- O-PACKAGE WITHOUT CAP

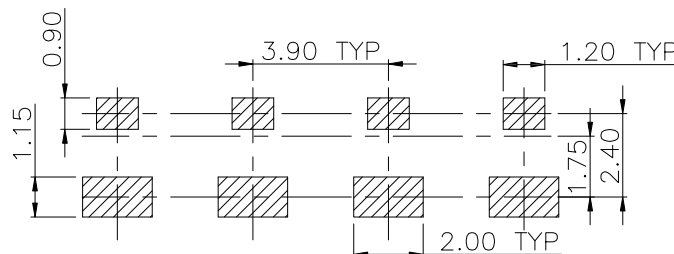
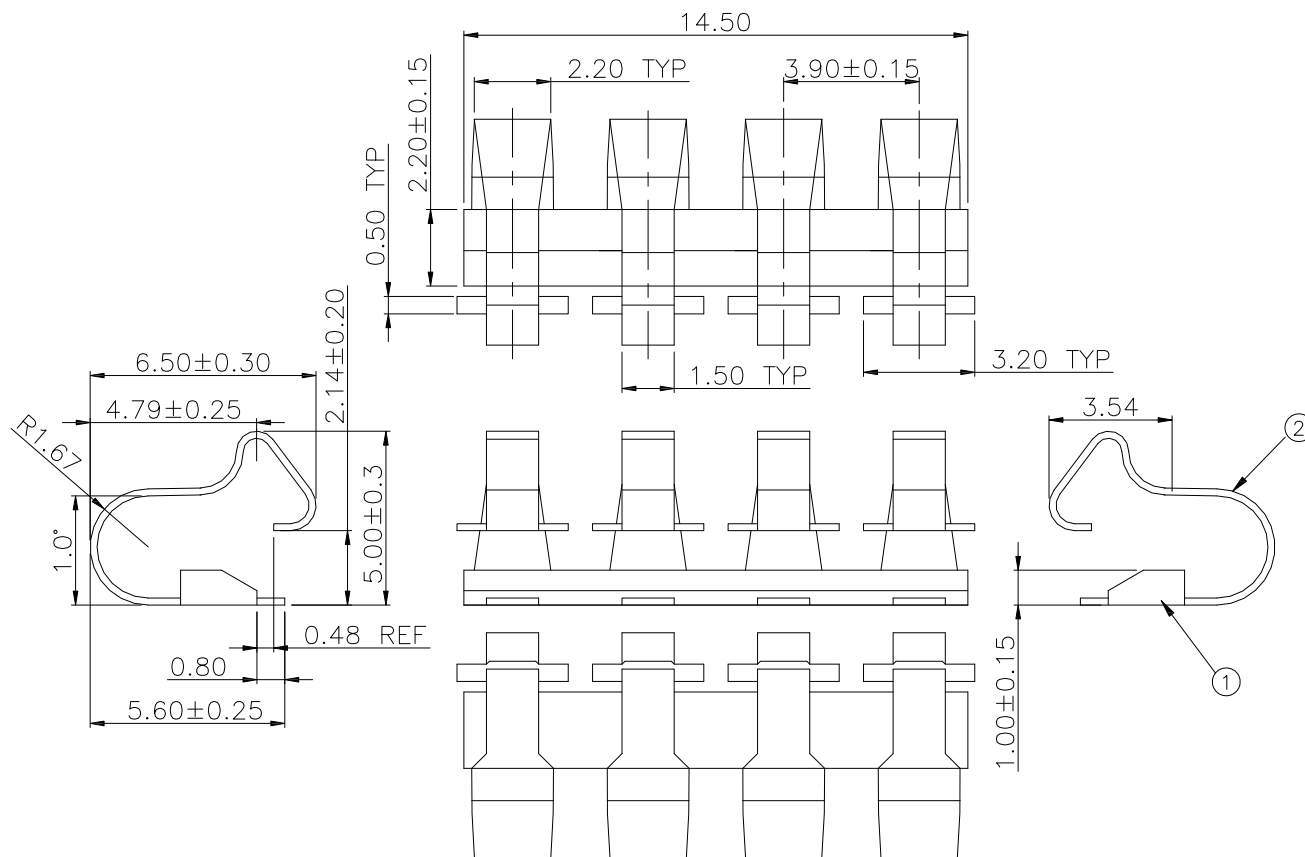



RECOMMENDED P.C.B LAYOUT

3				
2	TERMINAL	PHO.BRONZE	—	—
1	PLASTICS	HIGH TEMP PLASTICS	BLACK	UL94V-0
NO.	DESCRIPTION	MATERIAL	COLOR	REMARK

PROPRIETARY NOTE:

This document contains confidential information and proprietary to Rego Electronics and shall not be reproduced or disclosed to other documents or used for any purpose other than that for which was obtained without the expressed written consent of Rego Electronics.

.X ± 0.30	APPROVED:	 http://www.rego.com.tw
.XX ± 0.20	CHECKED: Chris	
.XXX ± 0.15	DRAWN: Andy	
X* ± 3'	DRAWN: Vic	
	UNITS: mm	SCALE: NONE
PART NO: RG060191-MA004S200ZL		SHEET: 1 OF 3

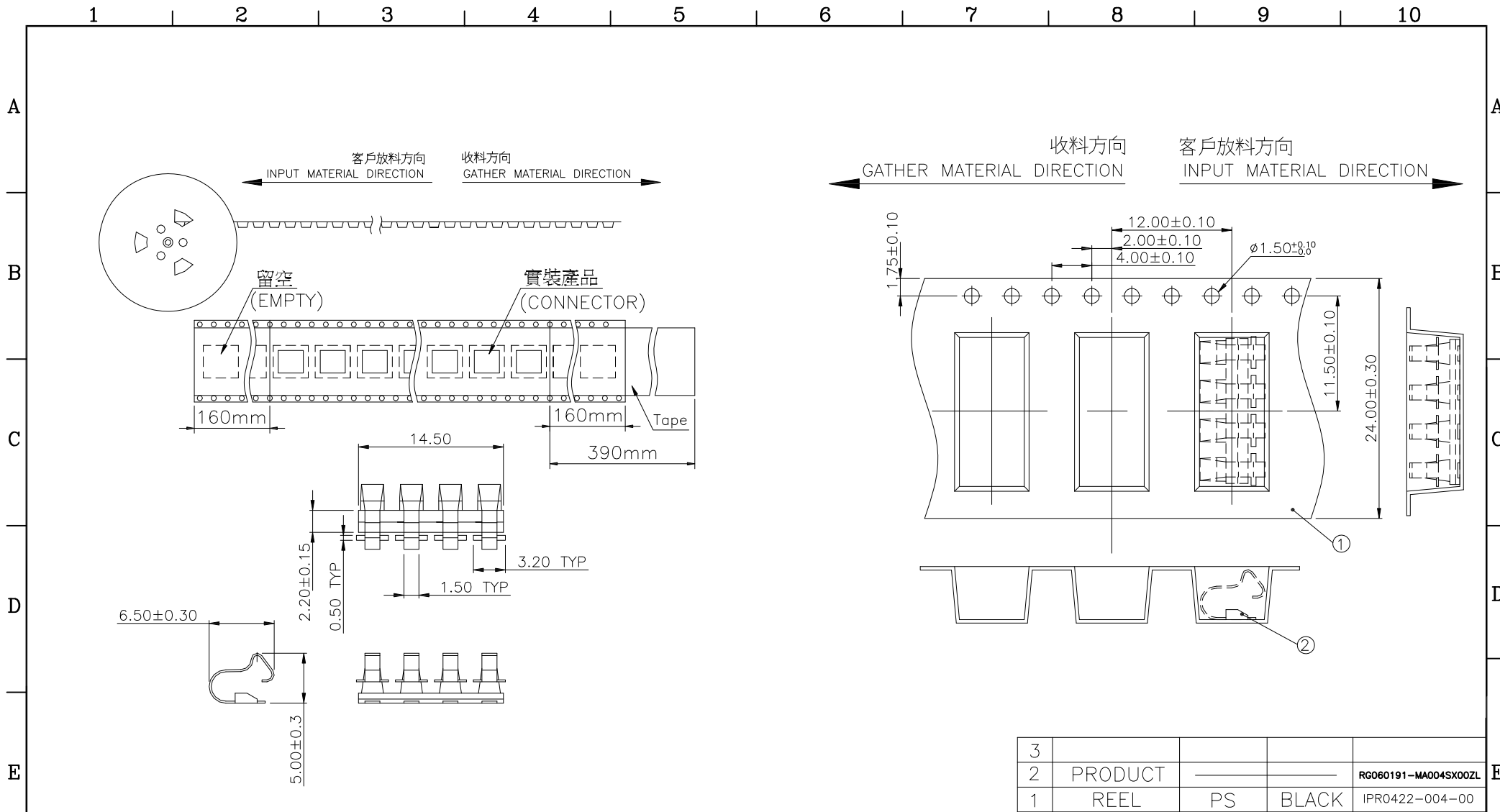

G	17.1.2010
REV	DATE

1 2 3 4 5 6 7 8 9 10



NOTE: All DIMENSIONSTOLERANCE R\ARE:
 1. ±0.25mm UNLESS OTHERWISE NOTED.
 2. COMONENT LOAD13" REEL.

PACKAGE INFORMATION			
PART NUMBER	Q'TY PER REEL	PACKING ROLLS IN ONE OUTER CARTON	Q'TY PER BOX
RG060191-MA004SX00ZL	1000PCS	8 R	8000 PCS

3				
2	PRODUCT			RG060191-MA004SX00ZL
1	REEL	PS	BLACK	IPR0422-004-00
	NO. DESCRIPTION	MATERIAL	COLOR	REMARK
PROPRIETARY NOTE: This document contains confidential information and proprietary to Rego Electronics and shall not be reproduced or disclosed to other documents or used for any purpose other than that for which was obtained without the expressed written consent of Rego Electronics.				
.X ± 0.30	APPROVED:	 http://www.rego.com.tw		
.XX ± 0.20	CHECKED: Chris			
.XXX ± 0.15	ANDY			
X* ± 3'	DRAWN: Vic	TITLE: 3.90mm PITCH BATTERY CONN MALE SMT TYPE		
	UNITS: mm	SCALE: NONE	PART NO: RG060191-MA004S200ZL	
			SHEET: 2 OF 3	

G	17.1.2010
REV	DATE

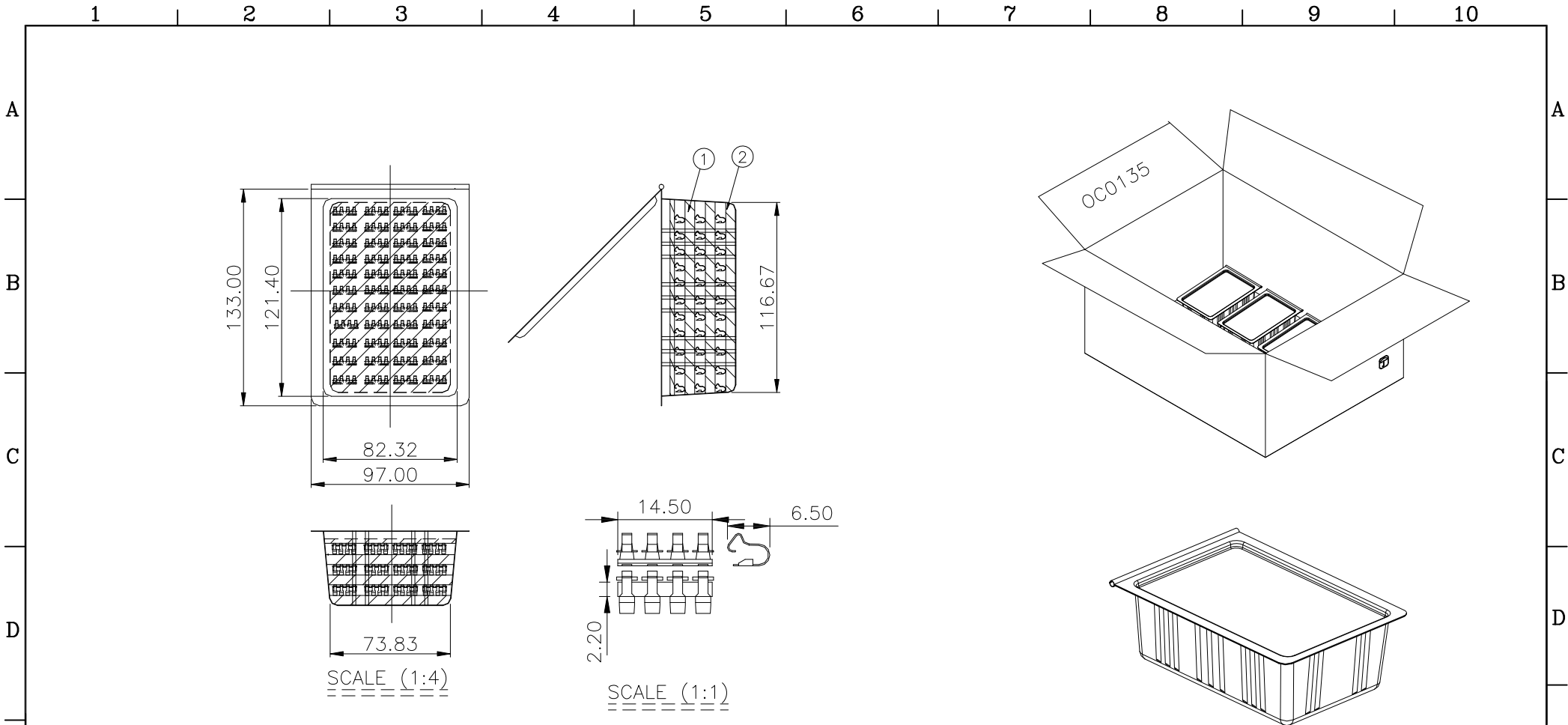

1 PACKAGE INFORMATION

PART NUMBER	THE NUMBER OF PRODUCTS IN A BISCUIT BOX	Q'TY PER BOX
RG060191-MA004SX00Z0	132 PCS	3168 PCS

- 2 NOTE: ALL DIMENSIONS TORLERANCE ARE:
- ±0.25mm UNLESS OTHERWISE NOTED.
 - THE OUTER CARTON USED FOR PACKING IS: OC0135

NO.	DESCRIPTION	MATERIAL	COLOR	REMARK
1	BISCUIT BOX	PVC	TRANS	CB0002

PROPRIETARY NOTE:
This document contains confidential information and proprietary to Rego Electronics and shall not be reproduced or disclosed to other documents or used for any purpose other than that for which was obtained without the expressed written consent of Rego Electronics.

.X ± 0.30	APPROVED: Chris	 http://www.rego.com.tw
.XX ± 0.20	CHECKED: Andy	
.XXX ± 0.15	DRAWN: Vic	
X* ± 3'		
UNITS: mm	SCALE: NONE	TITLE: 3.90mm PITCH BATTERY CONN MALE SMT TYPE
		PART NO: RG060191-MA004S200ZL
		SHEET: 3 OF 3

G	17.1.2010
REV	DATE