

1 2 3 4 5 6 7 8 9 10

A

B

C

D

E

F

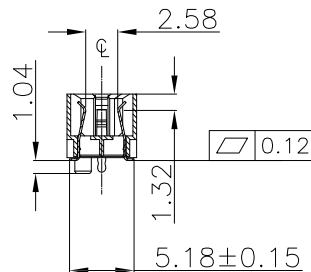
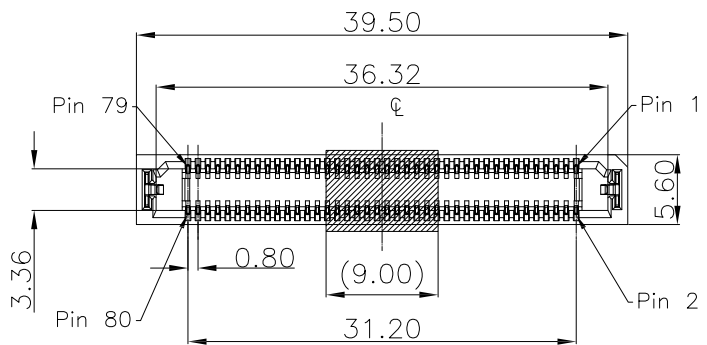

Section A-A

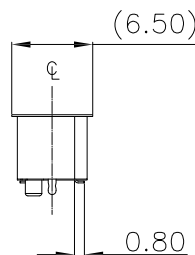
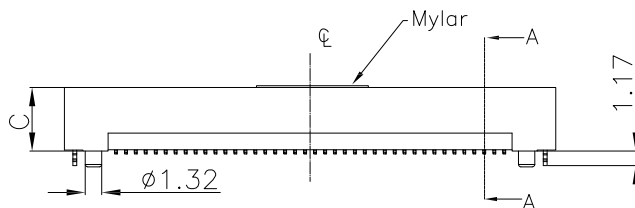

stacked height D

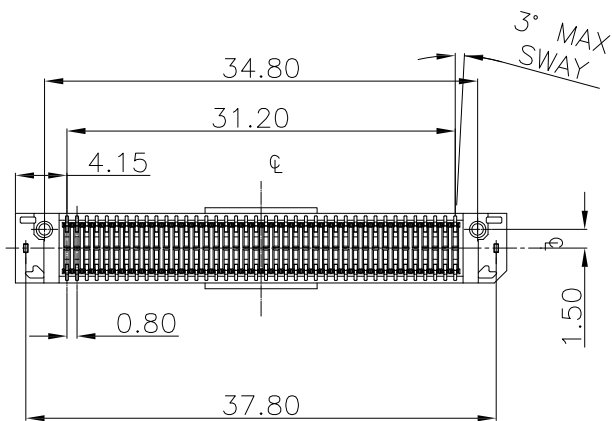
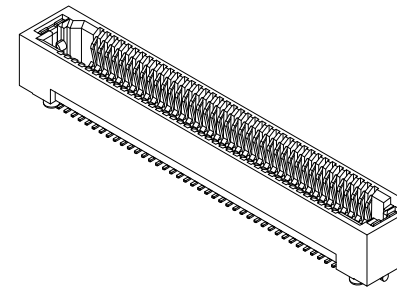

803HC86 - 2 2 X 40 C 3 D 1 L T - S
 Series ——— 2:Female Straight ——— C: Selective Gold Plated ——— 3: 10µ" ——— 7: 30µ" ——— D:SMD Type ———
 L: With lock
 T: Tape&Reel Package
 S: Mylar
 Blank: Without Mylar
 1:Code1
 2:Code2
 3:Code3
 4:Code4

PROPRIETARY NOTE:

This document contains confidential information and proprietary to Rego Electronics and shall not be reproduced or disclosed to other documents or used for any purpose other than that for which was obtained without the expressed written consent of Rego Electronics.

"*"Available Code																
Code	*1	2	3	4												
Height C	5.10	7.00	9.10	10.10												
Stacked Height D	7.0	10.0	13.0	14.0	9.0	12.0	15.0	16.0	11.0	14.0	17.0	18.0	12.0	15.0	18.0	19.0

.X ± 0.30	APPROVED: Chris	 http://www.rego.com.tw
.XX ± 0.20	CHECKED: Andy	
.XXX ± 0.15	DRAWN: Vic	TITLE: High Speed Board To Board Pitch : 0.8mm 80 Position Female Type
X* ± 3°	UNITS: mm	SCALE: NONE
PART NO: 803HC86-22x40C3D1LT-S		SHEET: 1 OF 2

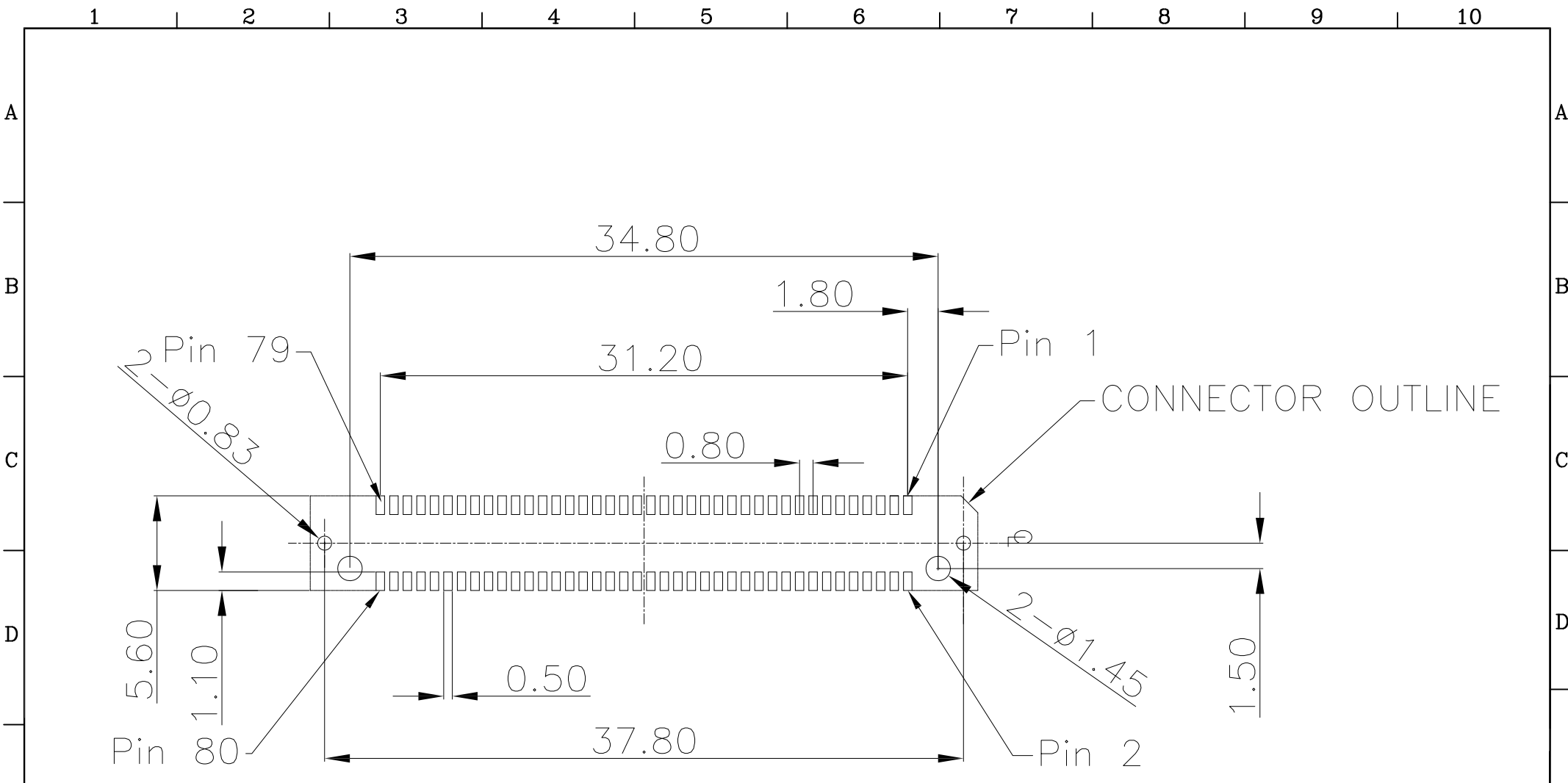

X6	08.8.2019
REV	DATE

1 2 3 4 5 6 7 8 9 10



Recommended PCB Layout
(Tolerance : ± 0.05)

PROPRIETARY NOTE:
This document contains confidential information and proprietary to Rego Electronics and shall not be reproduced or disclosed to other documents or used for any purpose other than that for which was obtained without the expressed written consent of Rego Electronics.

.X ± 0.30	APPROVED: Chris	 http://www.rego.com.tw
.XX ± 0.20	CHECKED: Andy	
.XXX ± 0.15	DRAWN: Vic	
X* $\pm 3'$		TITLE: High Speed Board To Board Pitch : 0.8mm 80 Position Female Type
	UNITS: mm	SCALE: NONE
		PART NO: 803HC86-22x40C3D1LT-S
		SHEET: 1 OF 2

X6	08.8.2019
REV	DATE